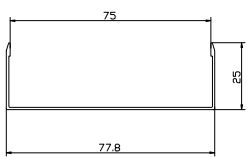
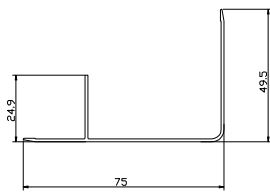
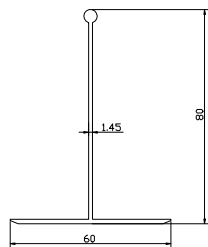
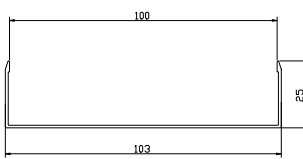
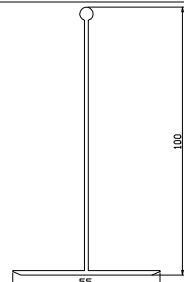

FW-JHLY-7525C09	
T= 0.9	
0.315 kg/m	
253.4 mm	

FW-JHLY-7550F11	
T= 1.1	
0.431 kg/m	
291.5 mm	

FW-JHLY-8060T16	
T= 1.45	
0.603 kg/m	
279.13 mm	

FW-JHLY-10025C10	
T= 1.0	
0.415 kg/m	
303.2 mm	

FW-JHLY-10055T17	
T=1.4	
0.638 kg/m	
311 mm	

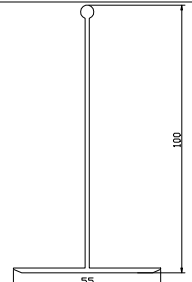
FW-JHLY-10055T18	
T= 1.52	
0.703 kg/m	
310.8 mm	

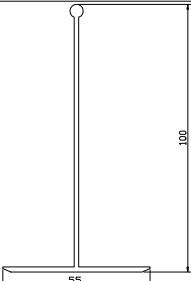
FW-JHLY-10055T19	
T= 1.67	
0.76 kg/m	
310.3 mm	

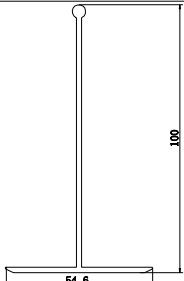
FW-JHLY-10055T21	
T= 1.9	
0.832 kg/m	
309.52 mm	

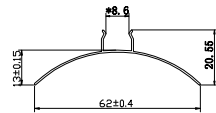
FW-JHLY-5519	
T= 0.67	
0.156 kg/m	
170.1 mm	

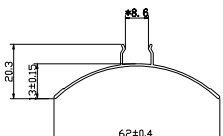
FW-JHLY-5519A	
T=0.82	
0.195 kg/m	
169.03 mm	

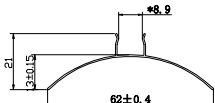
FW-JHLY-5519E	
T= 0.55	
0.128 kg/m	
170.9 mm	

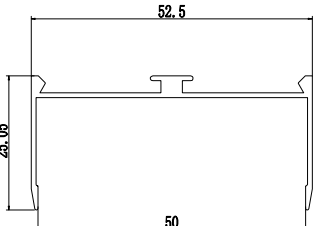
FW-JHLY-5515	
T= 0.9	
0.313 kg/m	
217.37 mm	

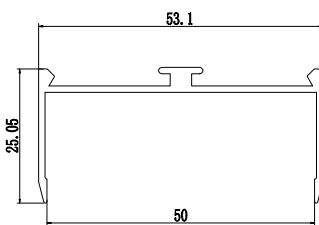
FW-JHLY-5515A	
T= 1.2	
0.4 kg/m	
218.44 mm	

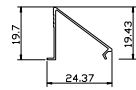
FW-JHLY-5516	
T=0.6	
0.092 kg/m	
107.57 mm	

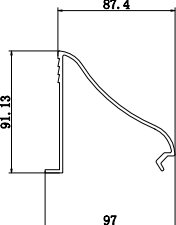
FW-JHLY-5517A	
T= 0.6	
0.102 kg/m	
121.11 mm	

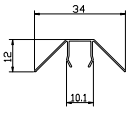
FW-JHLY-5520	
T= 0.6	
0.092 kg/m	
126.88 mm	

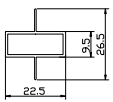
FW-JHLY-5522	
T= 0.6	
0.157 kg/m	
97.01 mm	

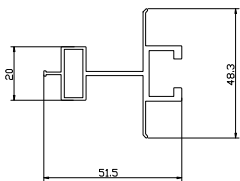
FW-JHLY-5523	
T=	
0.642 kg/m	
274.42 mm	